

ALEXANDER MILES

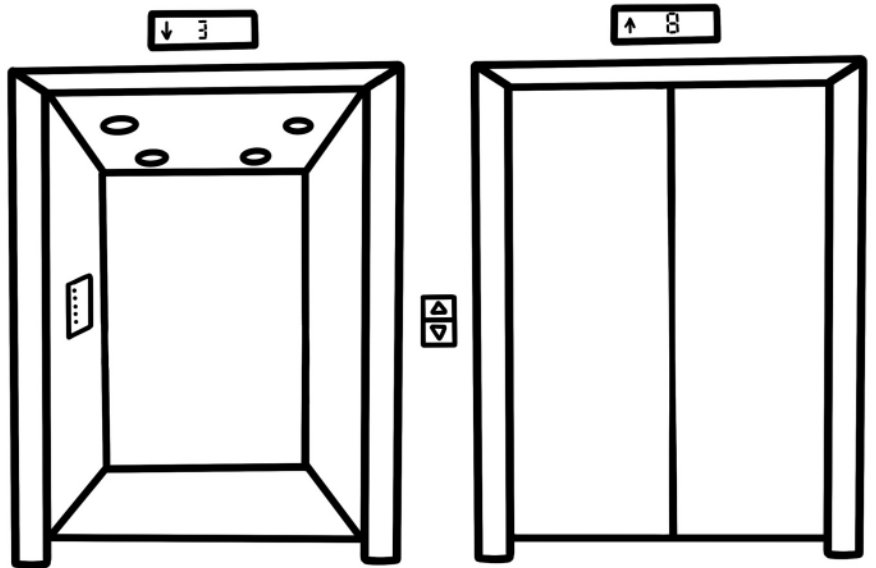

AUTOMATIC ELEVATOR DOORS.

ALFRED L. CRALLE

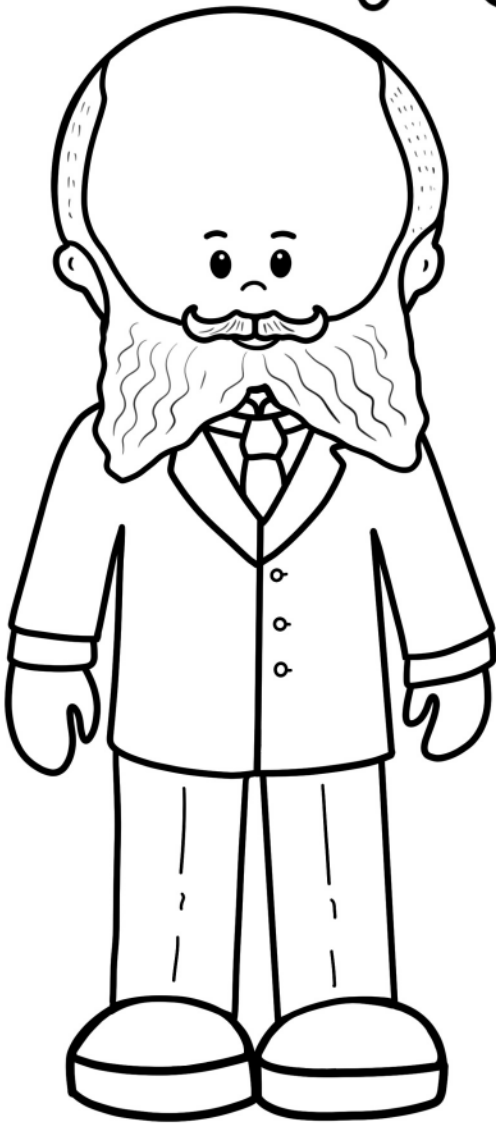
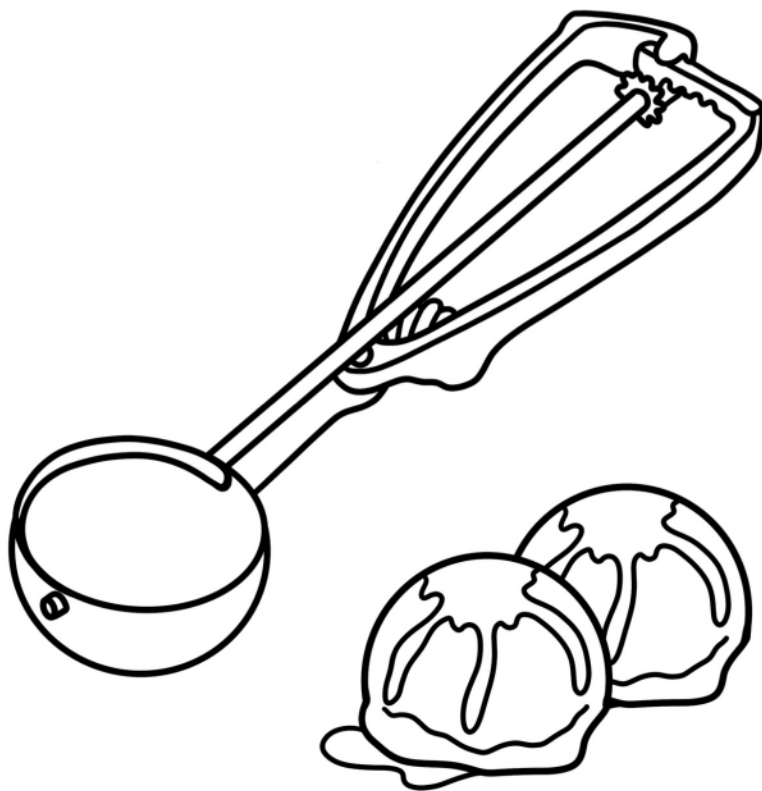
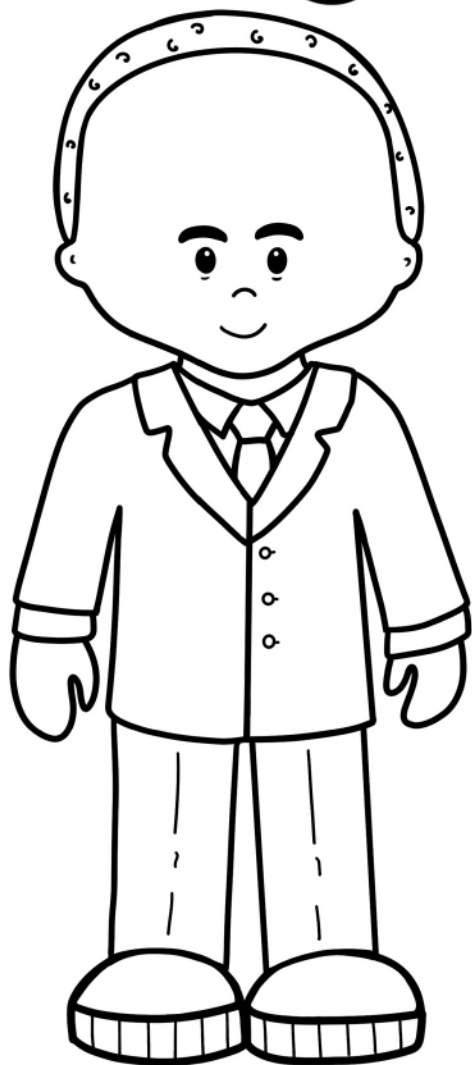

ICE CREAM SCOOP

ANNIE TURNBO MALONE

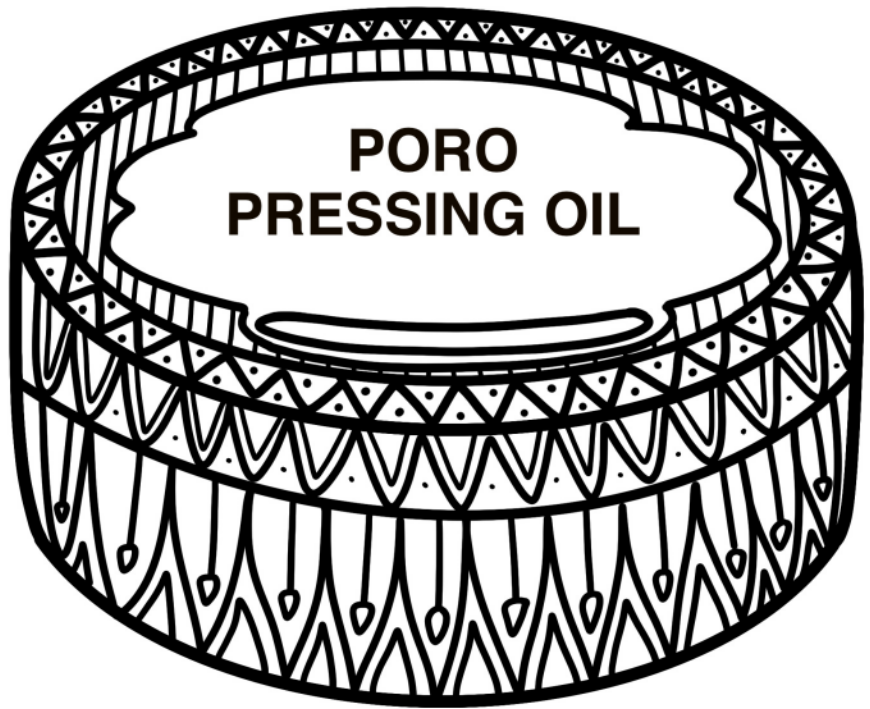
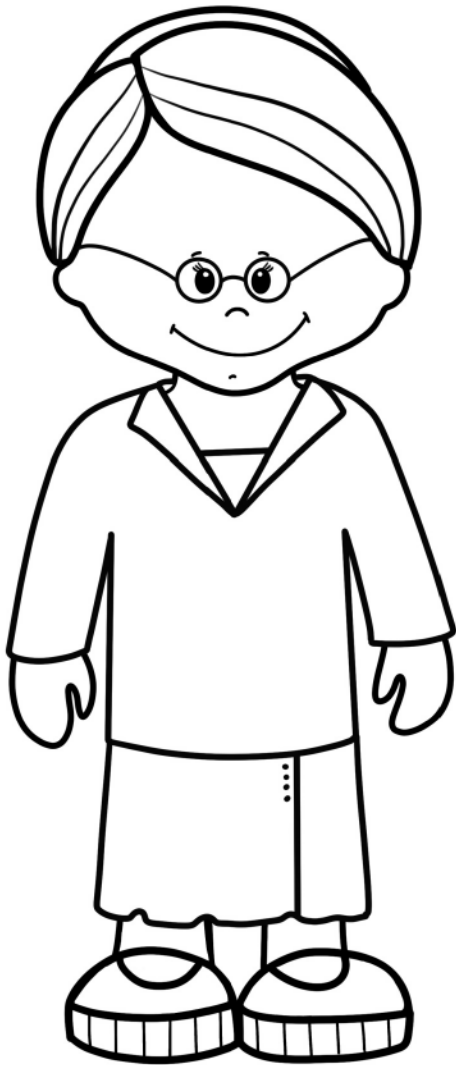

HAIR CARE PRODUCTS

GARRETT MORGAN

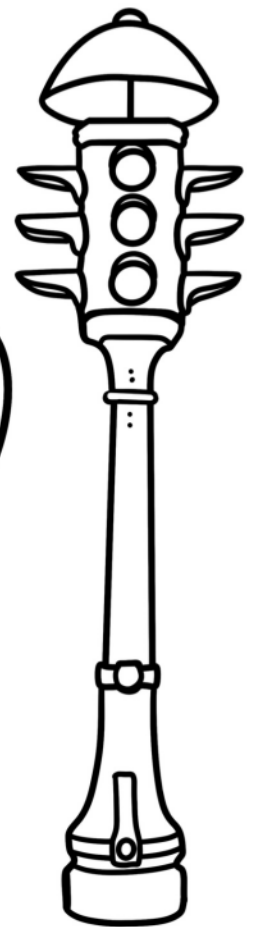
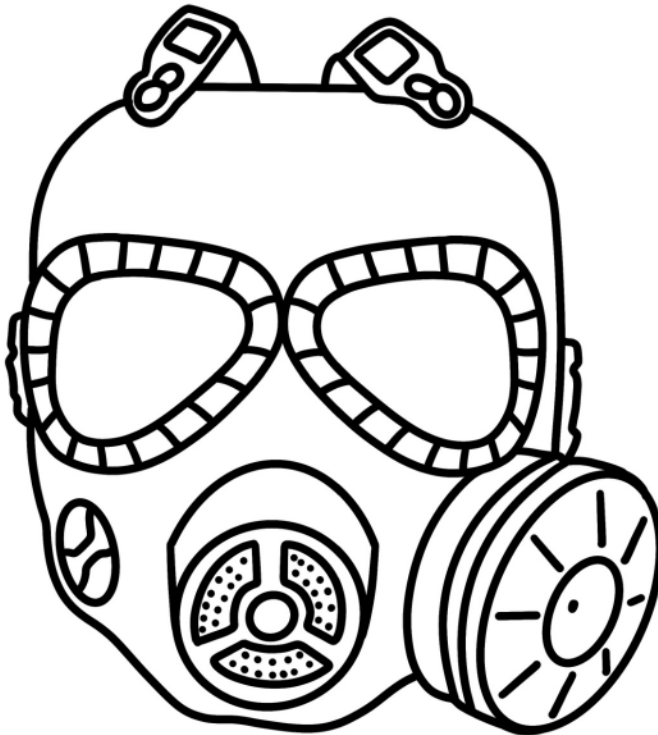
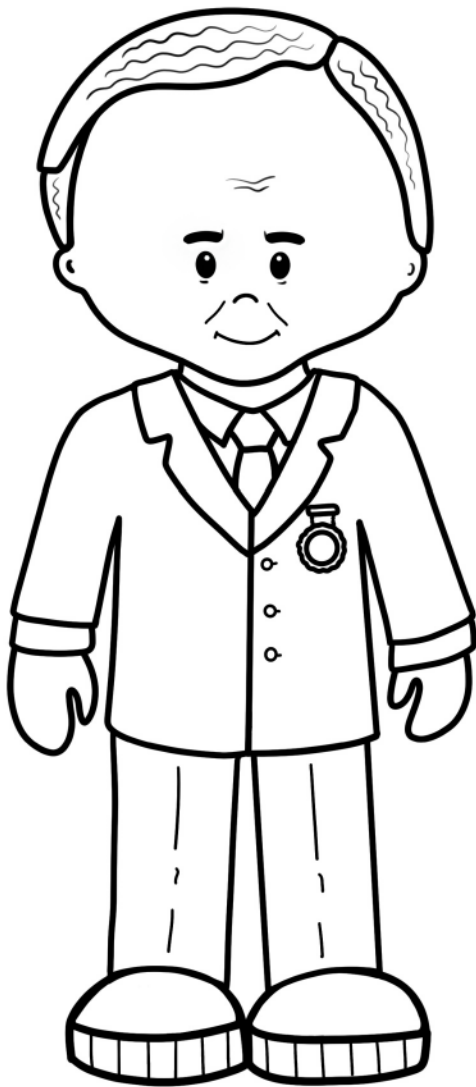

TRAFFIC LIGHTS & GAS MASK

GEORGE ROBERT CARRUTHERS

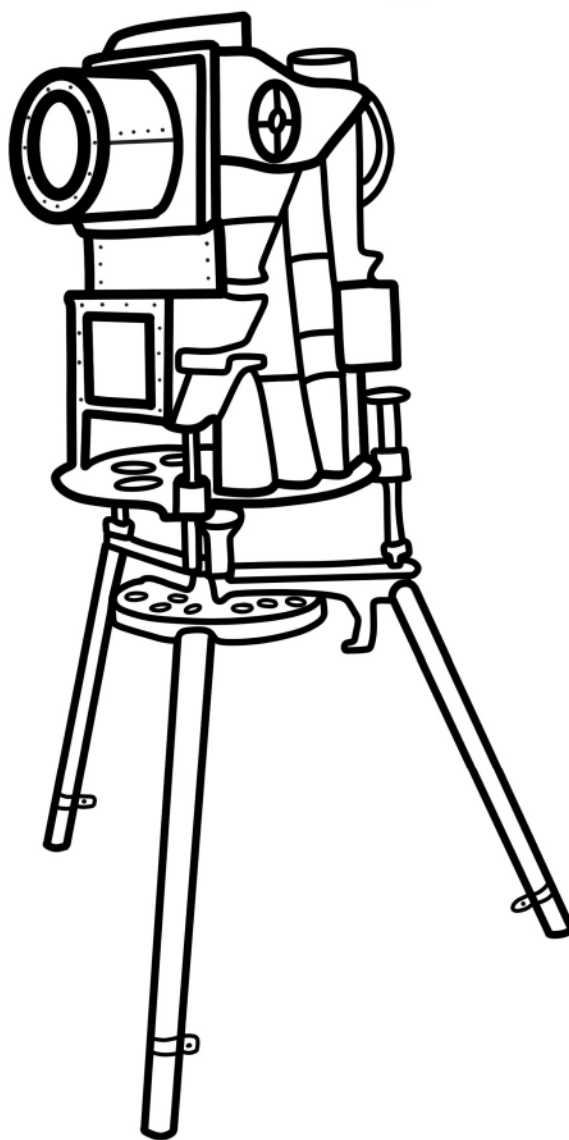
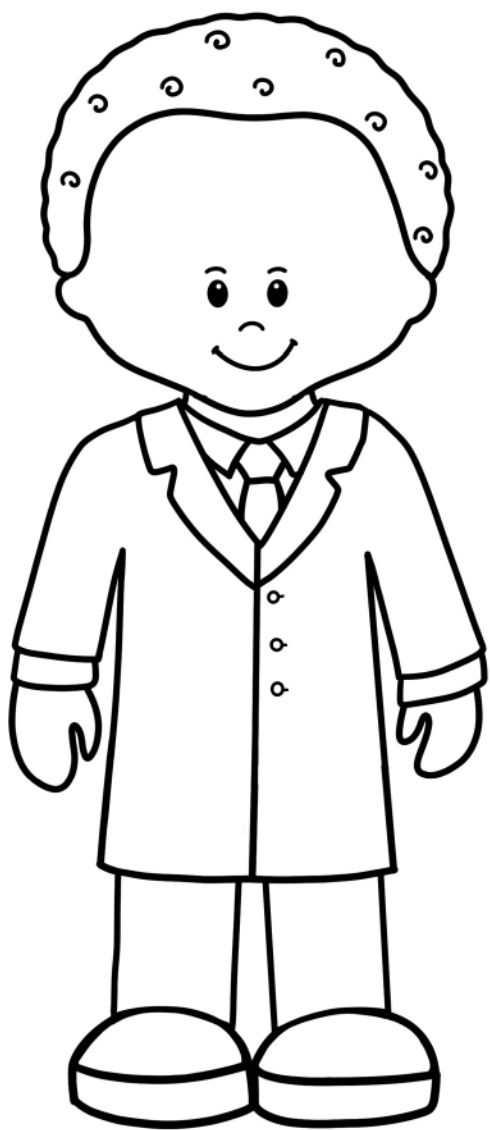

SPECTROGRAPH FOR NASA

GRANVILLE WOODS

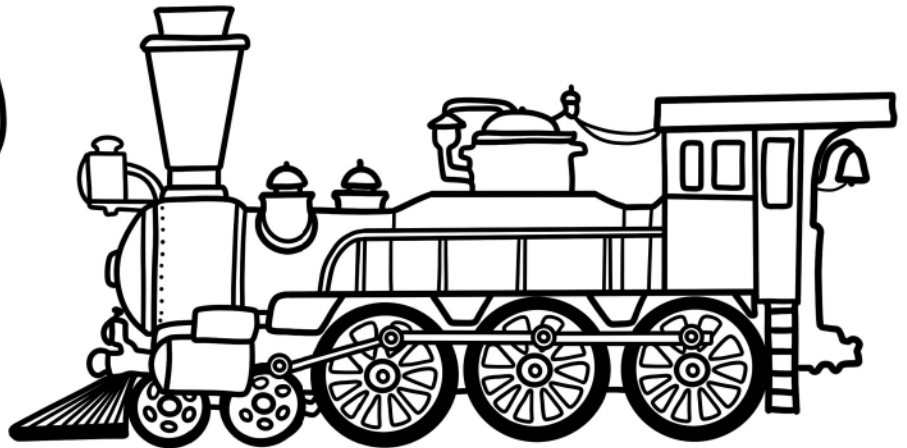
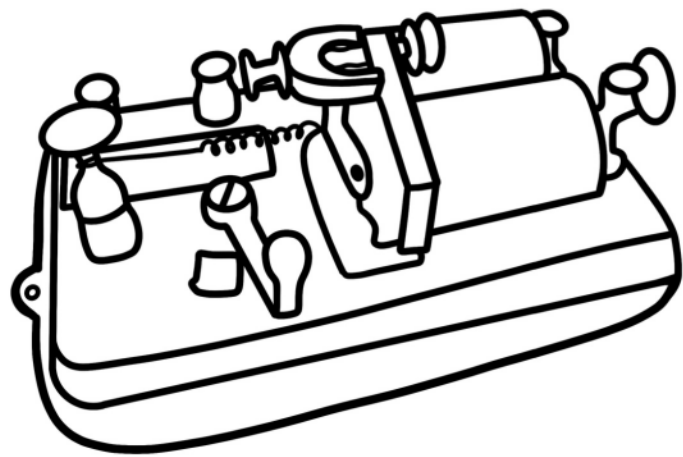
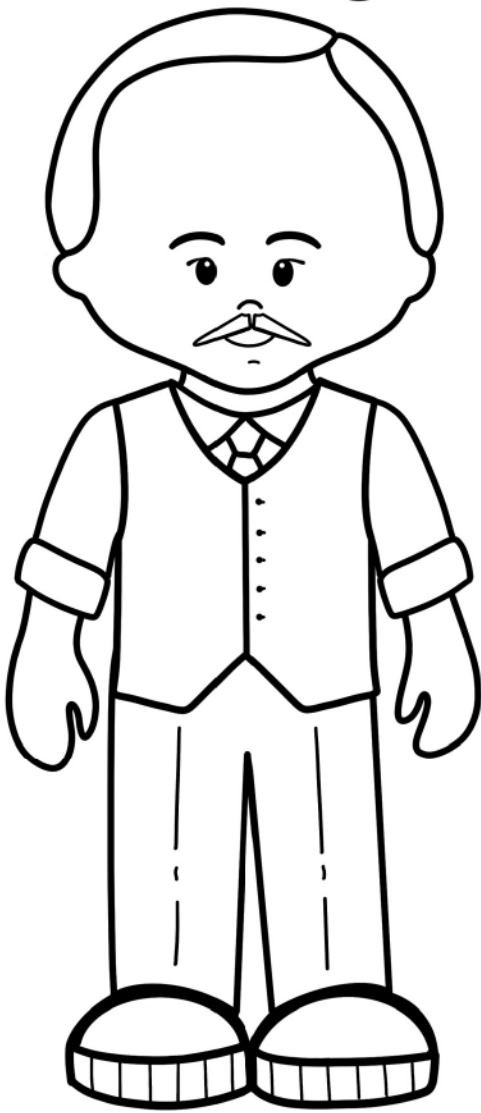

THE RAILROAD TELEGRAPH.

HENRY BLAIR

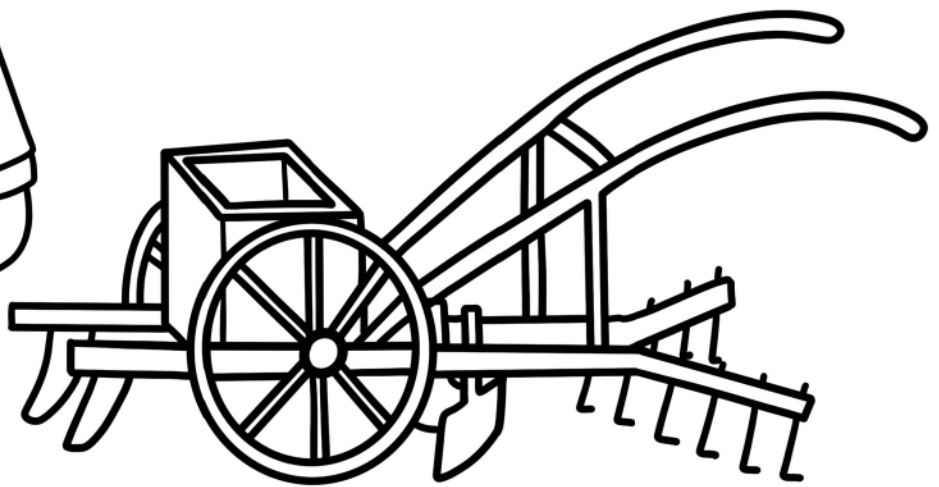
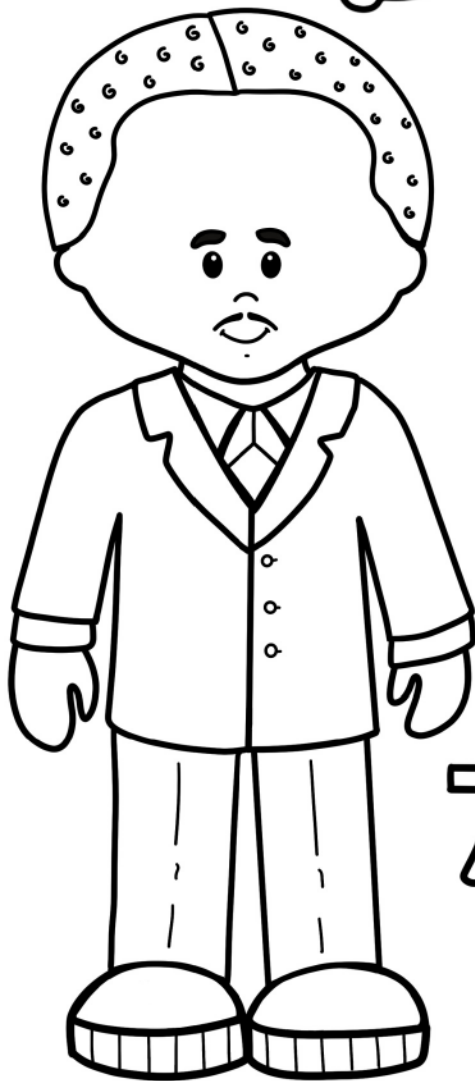

SEED PLANTER

JOSEPH WINTERS

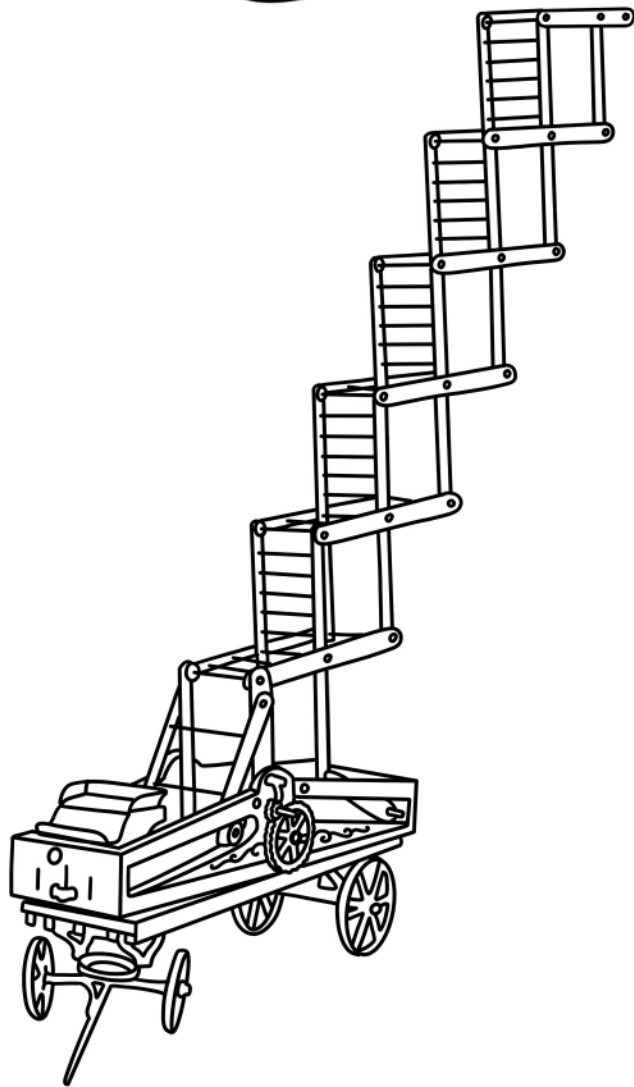

WAGON-MOUNTED FIRE ESCAPE LADDER

MARIE VAN BRITTAN BROWN

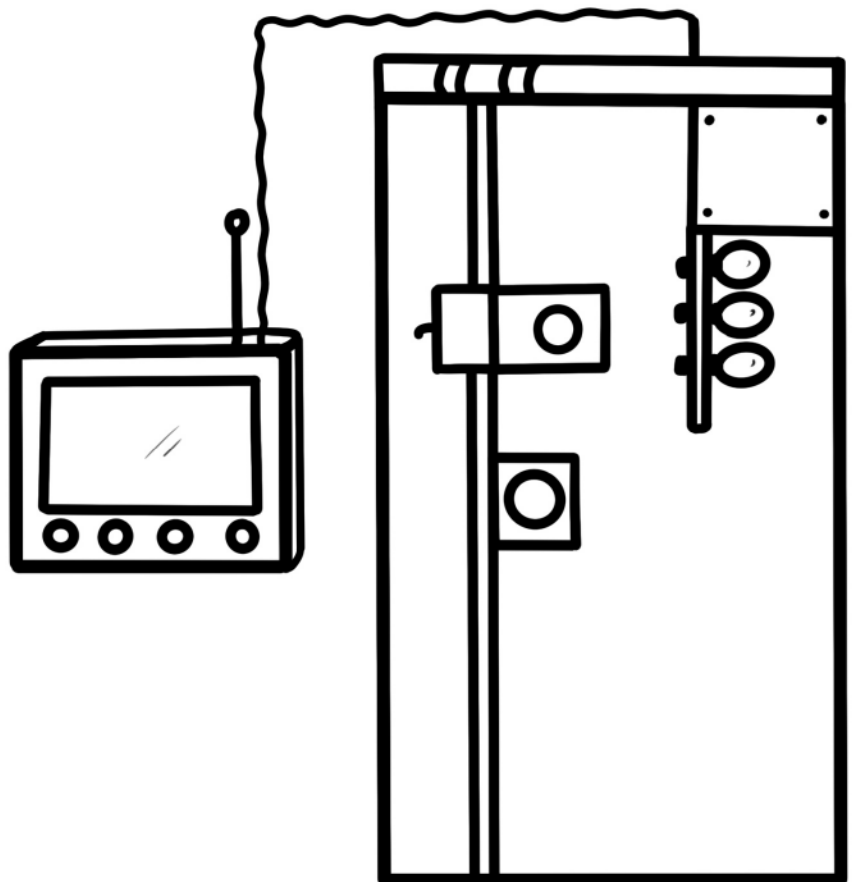
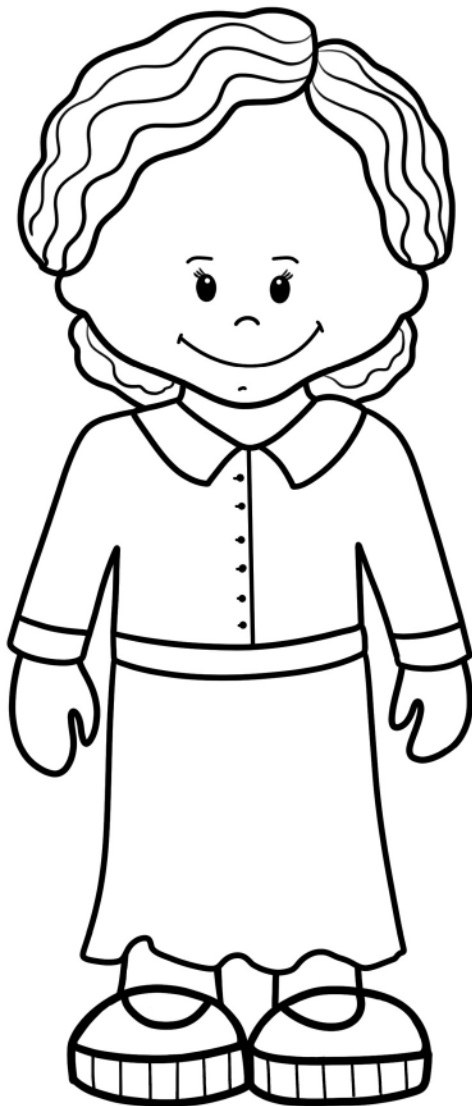

HOME SECURITY SYSTEM

SARAH E. GOODE

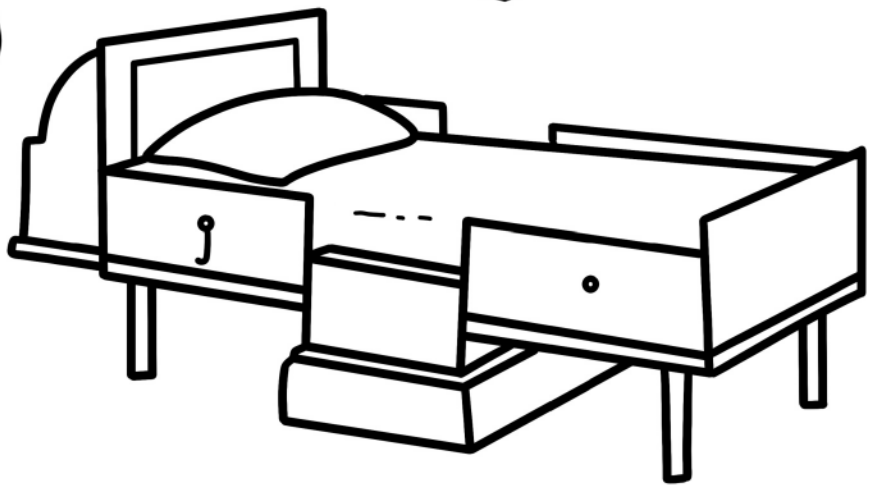
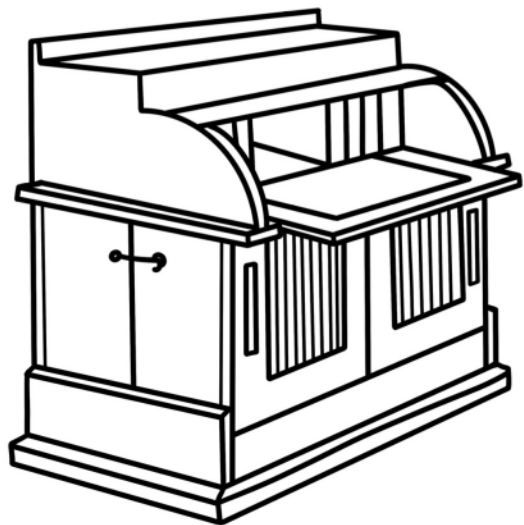

CABINET BED

Thank you for downloading!

Graphic Credit goes to:

